

茅ヶ崎市Ⅲ型雨水枡フラットタイプ(T-14・T-25)

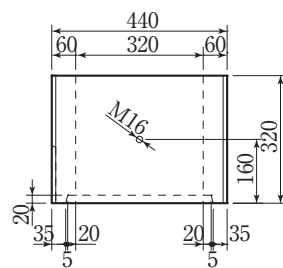
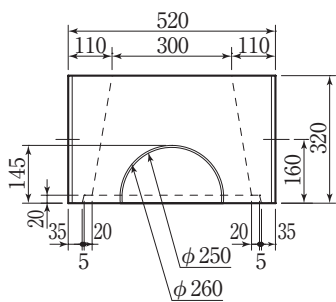
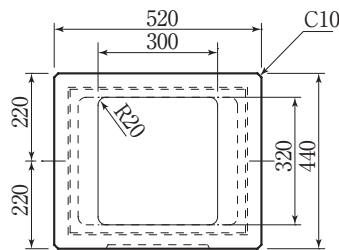
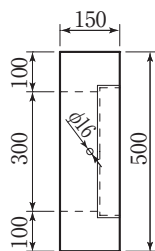
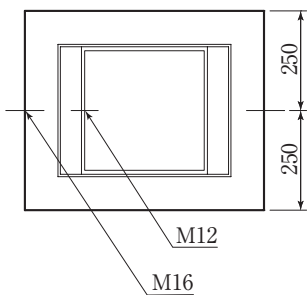
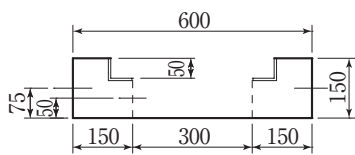

縁塊T=25

参考重量 (kg)
73

上部側塊

参考重量 (kg)
85

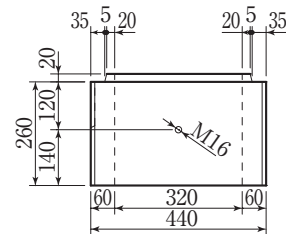
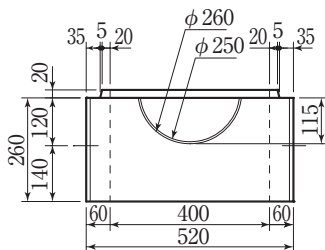
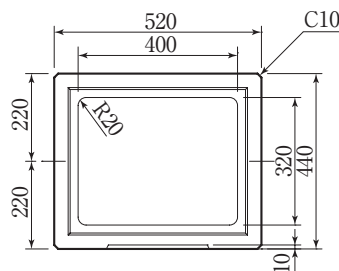
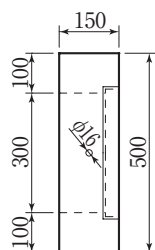
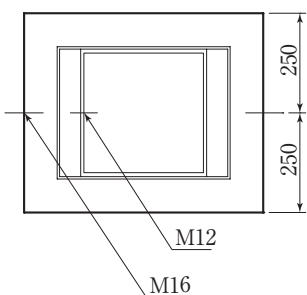
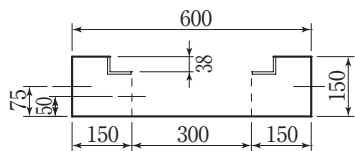

縁塊T=14

参考重量 (kg)
75

下部側塊

参考重量 (kg)
68