

横浜市型雨水ます(タイプ2)

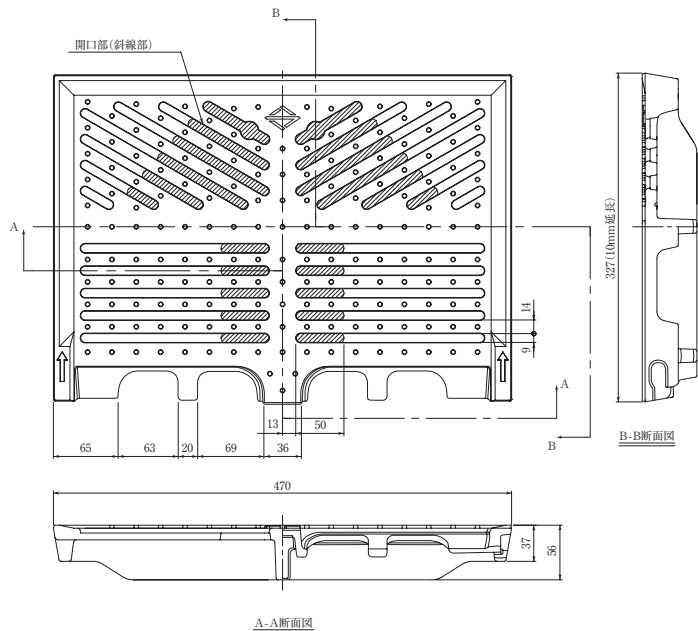

呼び	参考重量 (kg)
縁塊	57
上部側塊	50
中部側塊	74
下部側塊	88

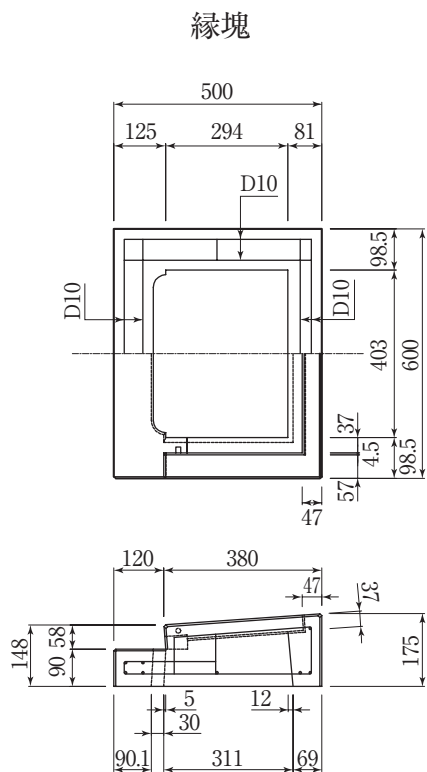